



COMPACT

HYDRAULIC MOTOR

HIGH TORQUE-LOW SPEED



TYPE		COMPACT							
MOTOR SIZE		40	50	75	100	150	200	300	400
DISPLACEMENT	cm ³	40.5	49.5	79.2	99.0	158.4	198.0	316.8	396.0
	in ³	2.47	3.02	4.83	6.04	9.66	12.10	19.30	24.16
MAX. SPEED	rpm cont.	1480	1210	755	605	378	303	190	150
	rpm int.	1555	1515	945	755	472	378	236	189
MAX. TORQUE	Nm cont.	52	94	150	190	310	360	360	360
	lbf.in cont.	460	835	1340	1680	2740	3180	3180	3180
	Nm int.	74	119	190	230	370	450	470	460
	lbf.in int.	660	1062	1680	2040	3280	3980	4160	4070
MAX. PRESSURE DROP	bar cont.	100	140	140	140	140	140	90	70
	psi cont.	1450	2030	2030	2030	2030	2030	1300	1015
	bar int.	140	175	175	175	175	175	120	90
	psi int.	2030	2540	2540	2540	2540	2540	1740	1310
MAX. OIL FLOW	lpm cont.	60	60	60	60	60	60	60	60
	gpm cont.	13.2	13.2	13.2	13.2	13.2	13.2	13.2	13.2
	lpm int.	70	75	75	75	75	75	75	75
	gpm int.	15.4	16.5	16.5	16.5	16.5	16.5	16.5	16.5
WEIGHT kg	Rear Ports	5.00	5.10	5.25	5.50	5.75	6.00	6.50	7.00
	Side Ports	5.25	5.35	5.50	5.75	6.00	6.25	6.75	7.25
	Rear Flange	5.40	5.50	5.65	5.90	6.15	6.40	6.90	7.40

Maximum inlet pressure 3250 psi - 224 bar
High pressure shaft seal drain line not required for most applications.

Maximum pressure drop and speed must not be reached simultaneously.
Intermittent operation may occur for 10% max. of every minute.

At speeds lower than 10 rpm please consult our Technical Department.

Mineral based hydraulic fluids with anti-wear additives are recommended with a viscosity of 35 mm²/s at a temperature of 50 C.

Minimum recommended oil viscosity 13 mm²/s at operating temperature.

Recommended oil cleanliness ISO 19/14 with a nominal filtration of 25 micron or better.

Where non-flammable fluids are to be used it is advisable to consult our Technical Department.

Ambient temperature should be between -30°C and +90°C.

Normal operating temperature should be between +30°C and +60°C.

Maximum operating temperature +85°C.

SYMBOL

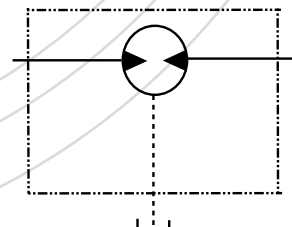

The policy of Adan Limited is one of continual development and the right is reserved to alter specifications without notice.



ADAN LIMITED

RIVERSIDE INDUSTRIAL ESTATE, BOSTON, LINCOLNSHIRE, ENGLAND

Tel: +44 (01205) 311500

Fax: +44 (01205) 358013

e mail: sales@adanltd.co.uk

website: www.adanltd.co.uk



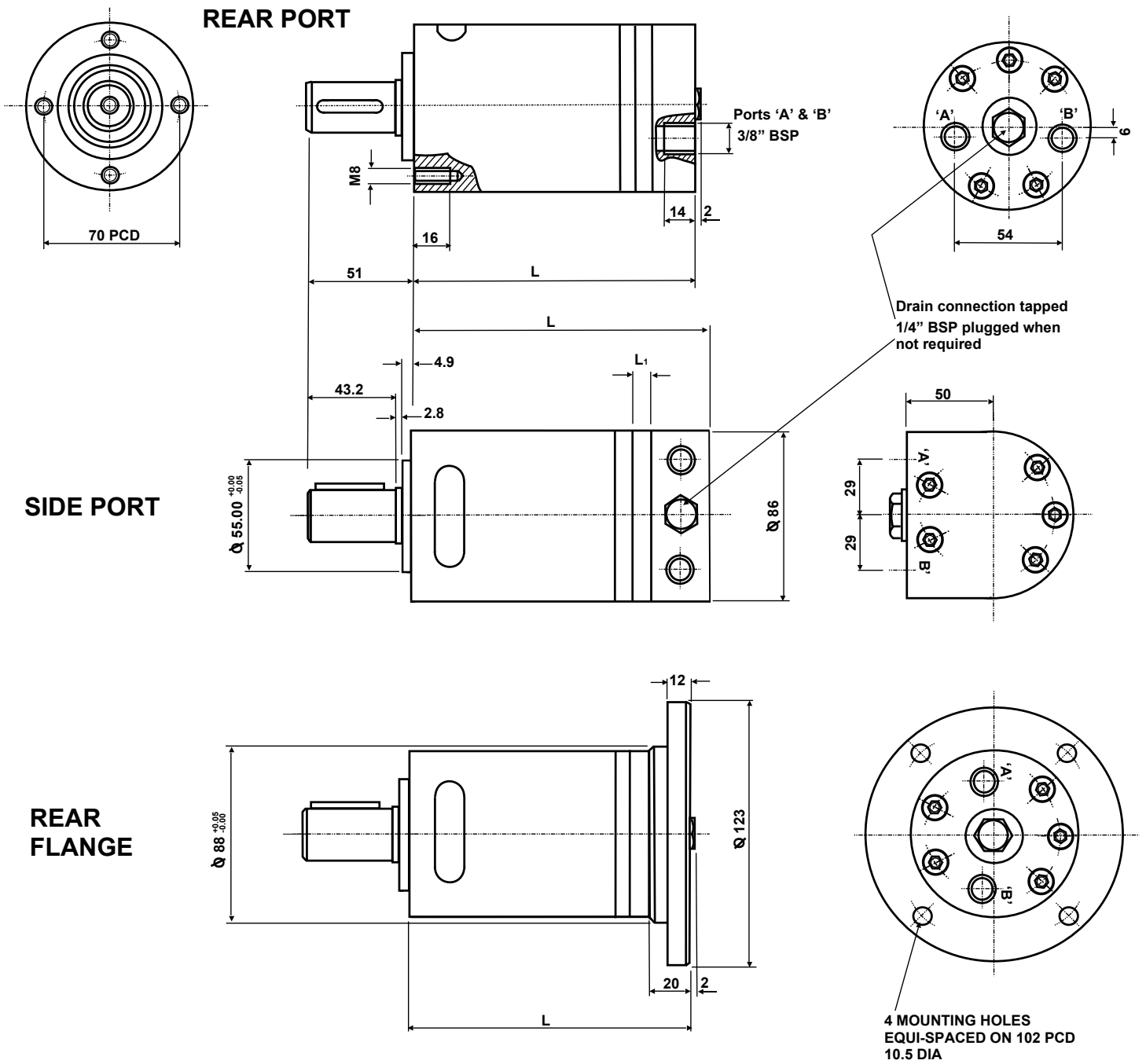

Motor size	Dimn.	40	50	75	100	150	200	300	400
ALL TYPES	L ₁	7.4	6.7	10.7	13.3	21.3	26.7	42.7	53.3
Rear Ports	L	137.3	136.6	140.6	143.2	151.2	166.6	172.6	183.2
Side Ports	L	140.3	139.6	143.6	146.2	154.2	159.6	175.6	186.2
Rear Flange	L	137.3	136.6	140.6	143.2	151.2	166.6	172.6	183.2

Metric Shaft - M

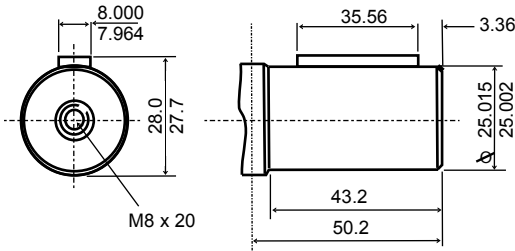

Imperial Shaft -

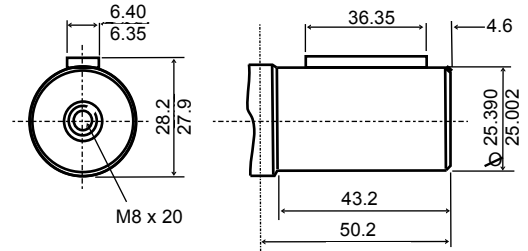

Splined Shaft - S

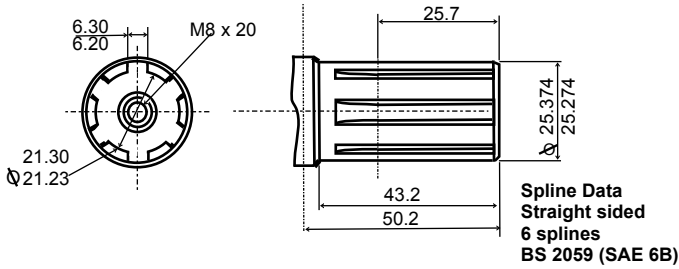

Tapered Shaft - T

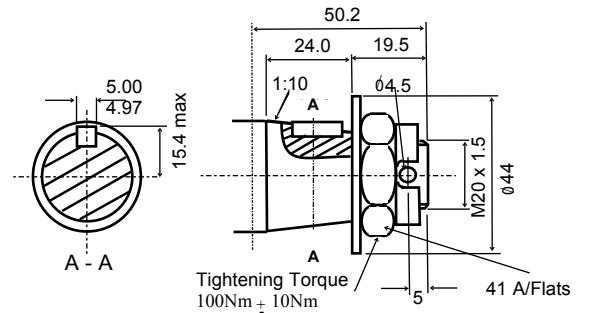

Splined Shaft - SP

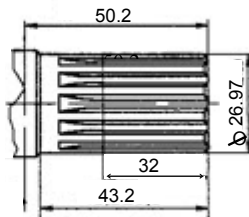

Metric Shaft - M28

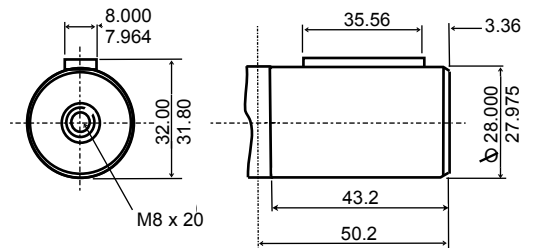

Splined Shaft - SS

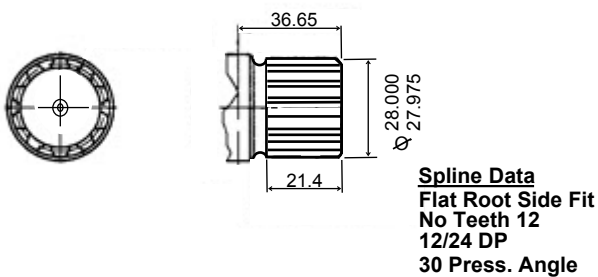

Metric Shaft - M24

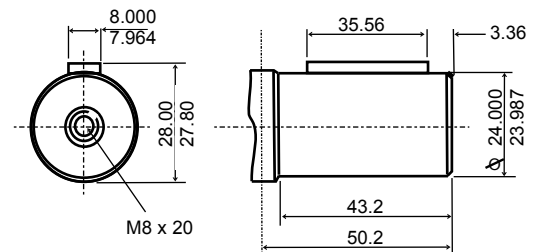

Note Torque limitations

Shafts M, E & M24 cont. 300 Nm (2660lbf.in) int. 420 Nm (3720lbf.in)

Shafts M28, S, SP, SS & T cont. 360 Nm (3190 lbf.in) int. 470 Nm (4160 lbf.in)

The policy of Adan Limited is one of continual development and the right is reserved to alter specifications without notice.



ADAN LIMITED

RIVERSIDE IND. ESTATE BOSTON LINCOLNSHIRE ENGLAND
 Tel: +44 (01205) 311500 Fax: +44 (01205) 358013
 email: sales@adanltd.co.uk website: www.adanltd.co.uk



SHAFT ROTATION

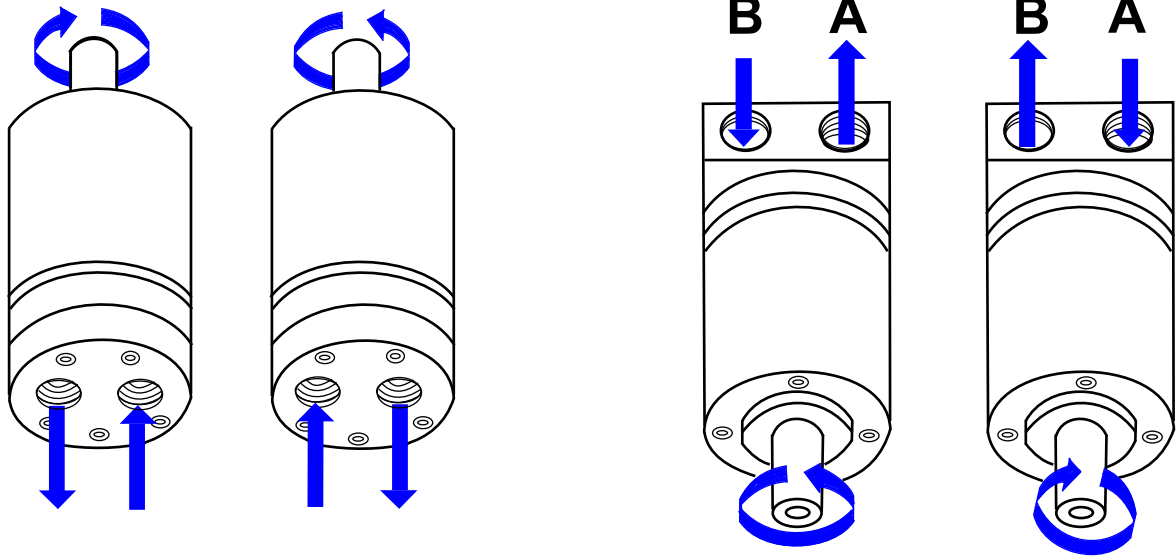

RADIAL SHAFT LOADS

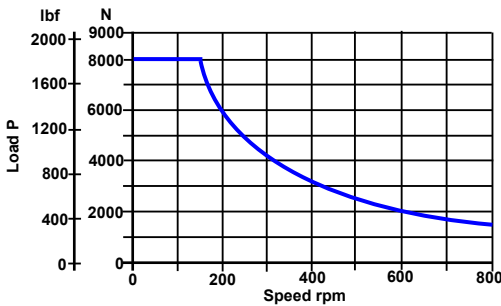

330 lbf
1408 N

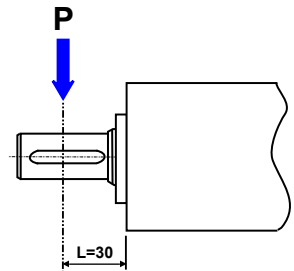

$$P = \frac{800}{n} \times \frac{250000}{95 + L} \text{ N}$$

$$P = \frac{800}{n} \times \frac{2215}{3.74 + L} \text{ lbf}$$

n = speed rpm
For metric L in mm
For imperial L in inches

ORDERING CODE

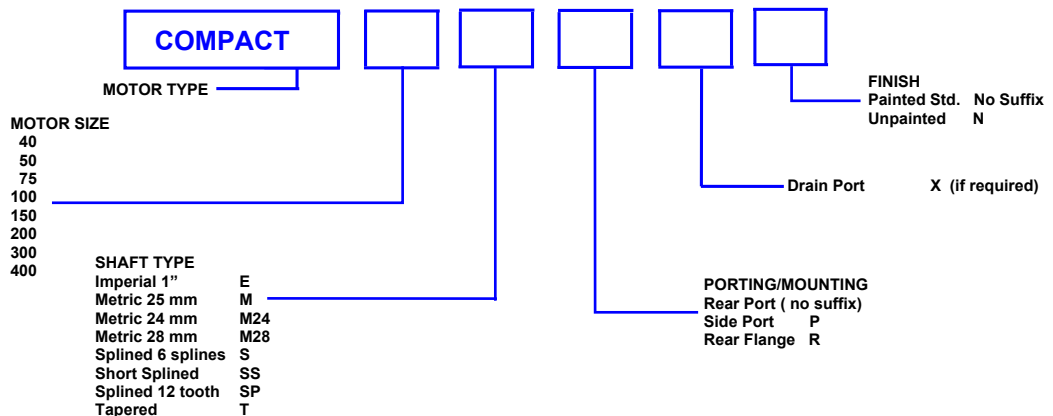

The policy of Adan Limited is one of continual development and the right is reserved to alter specifications without notice.



ADAN LIMITED

RIVERSIDE IND. ESTATE BOSTON LINCOLNSHIRE ENGLAND
Tel: +44 (01205) 311500 Fax: +44 (01205) 358013
email: sales@adanltd.co.uk website: www.adanltd.co.uk



PERFORMANCE GRAPHS 40 & 50 cc COMPACT SERIES

Solid blue lines represent continuous operation. Dotted red lines represent intermittent operation permissible for 10% of every minute.

Maximum pressure drop and maximum speed must not occur simultaneously.

Maximum values are dependant on shaft type see note on page 3.

COMPACT 40

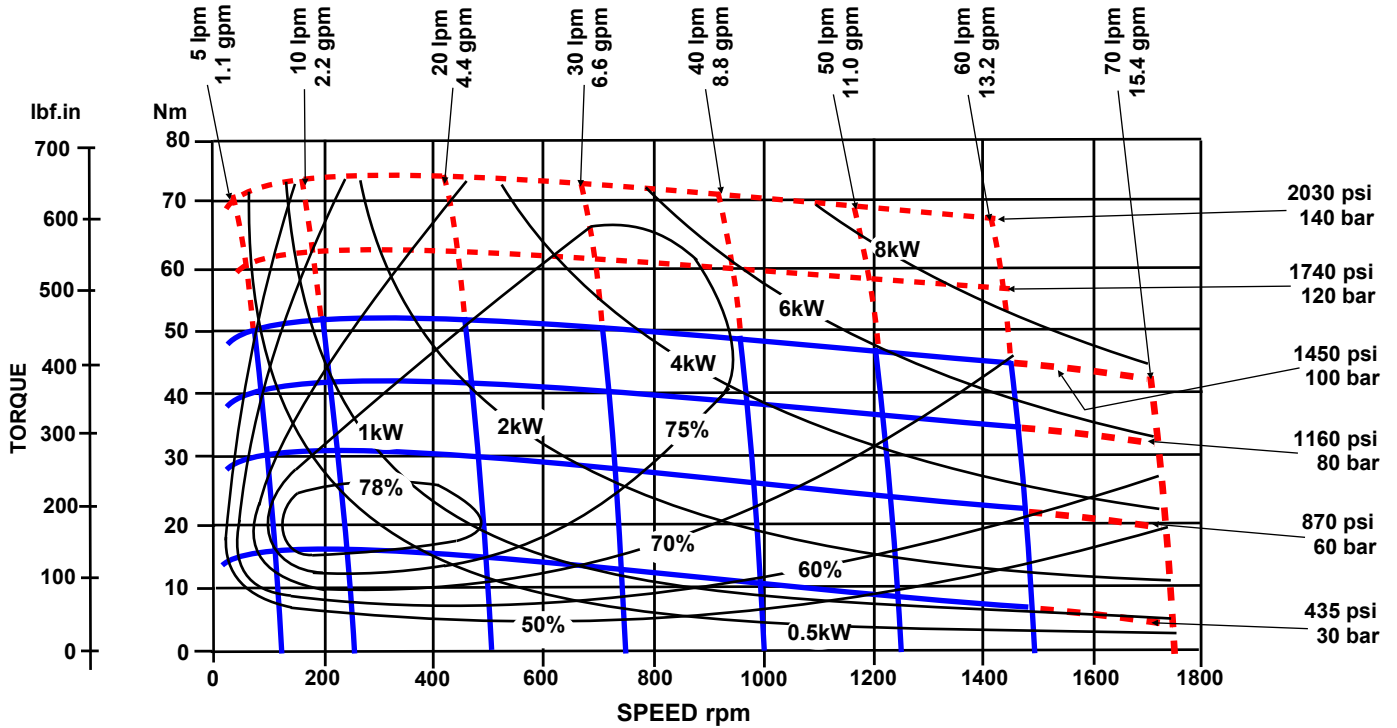

COMPACT 50

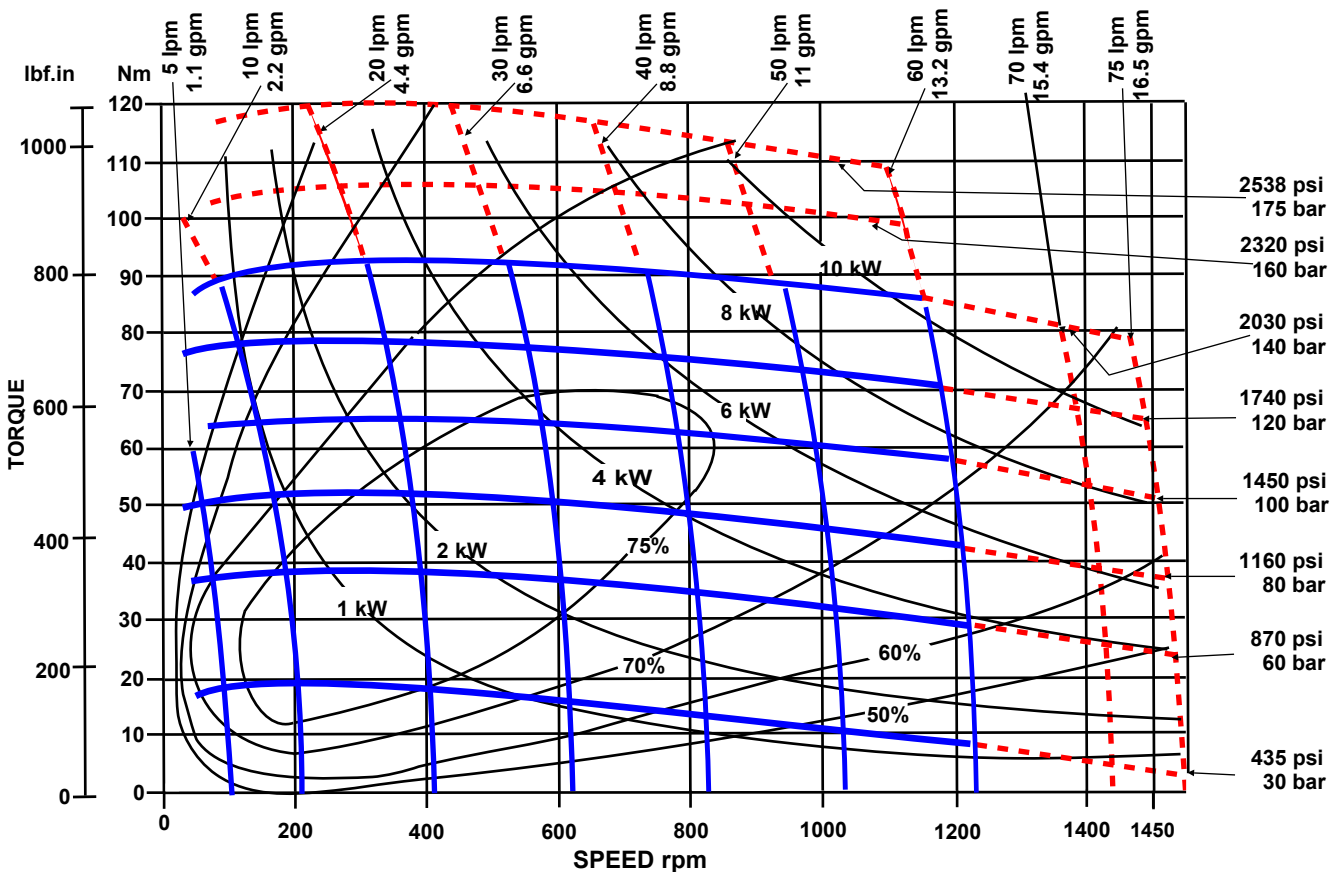

PERFORMANCE GRAPHS 75 & 100 cc COMPACT SERIES

Solid blue lines represent continuous operation. Dotted red lines represent intermittent operation permissible for 10% of every minute.

Maximum pressure drop and maximum speed must not occur simultaneously.

Maximum values are dependant on shaft type see note on page 3.

COMPACT 75

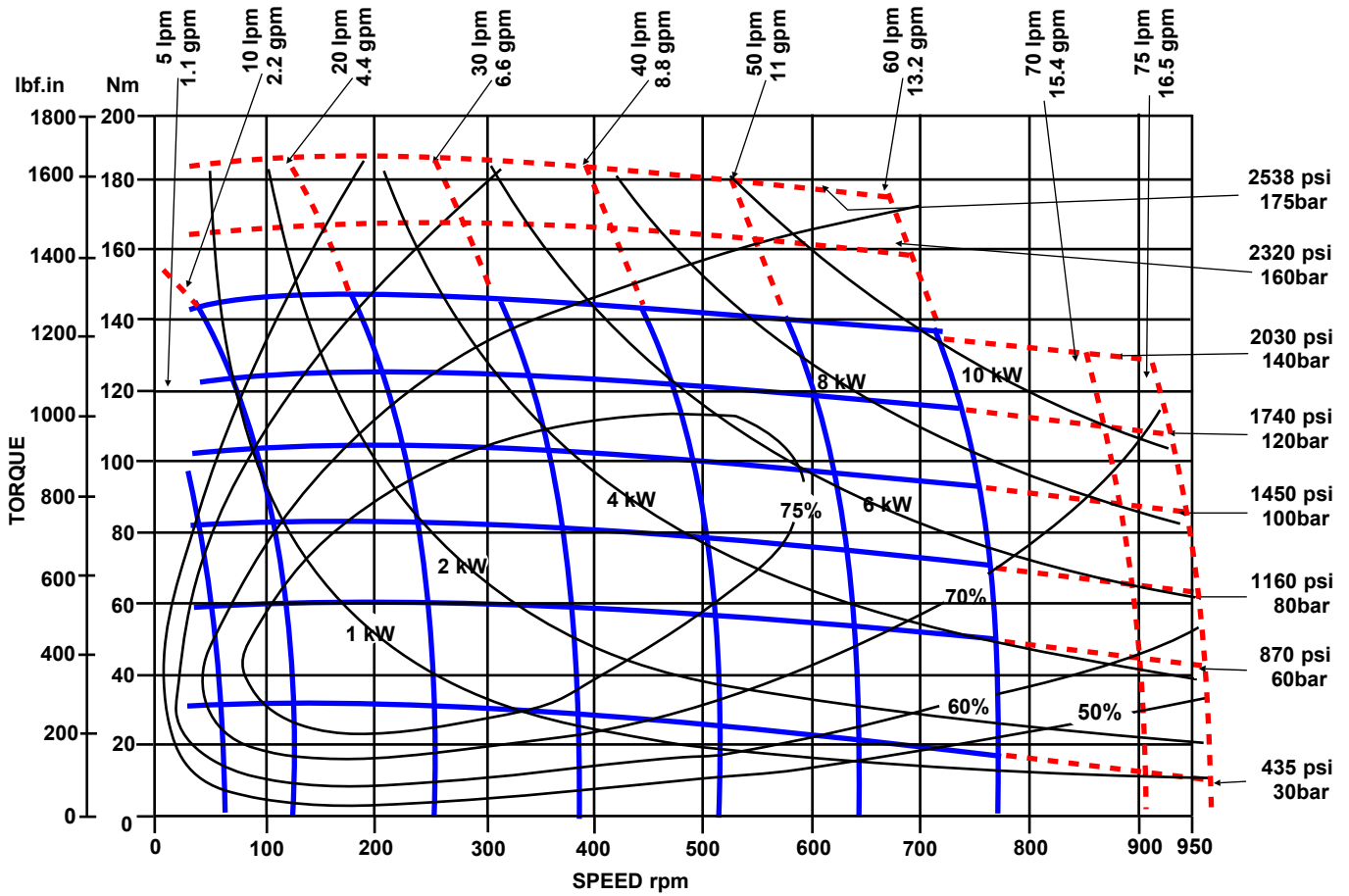

COMPACT 100

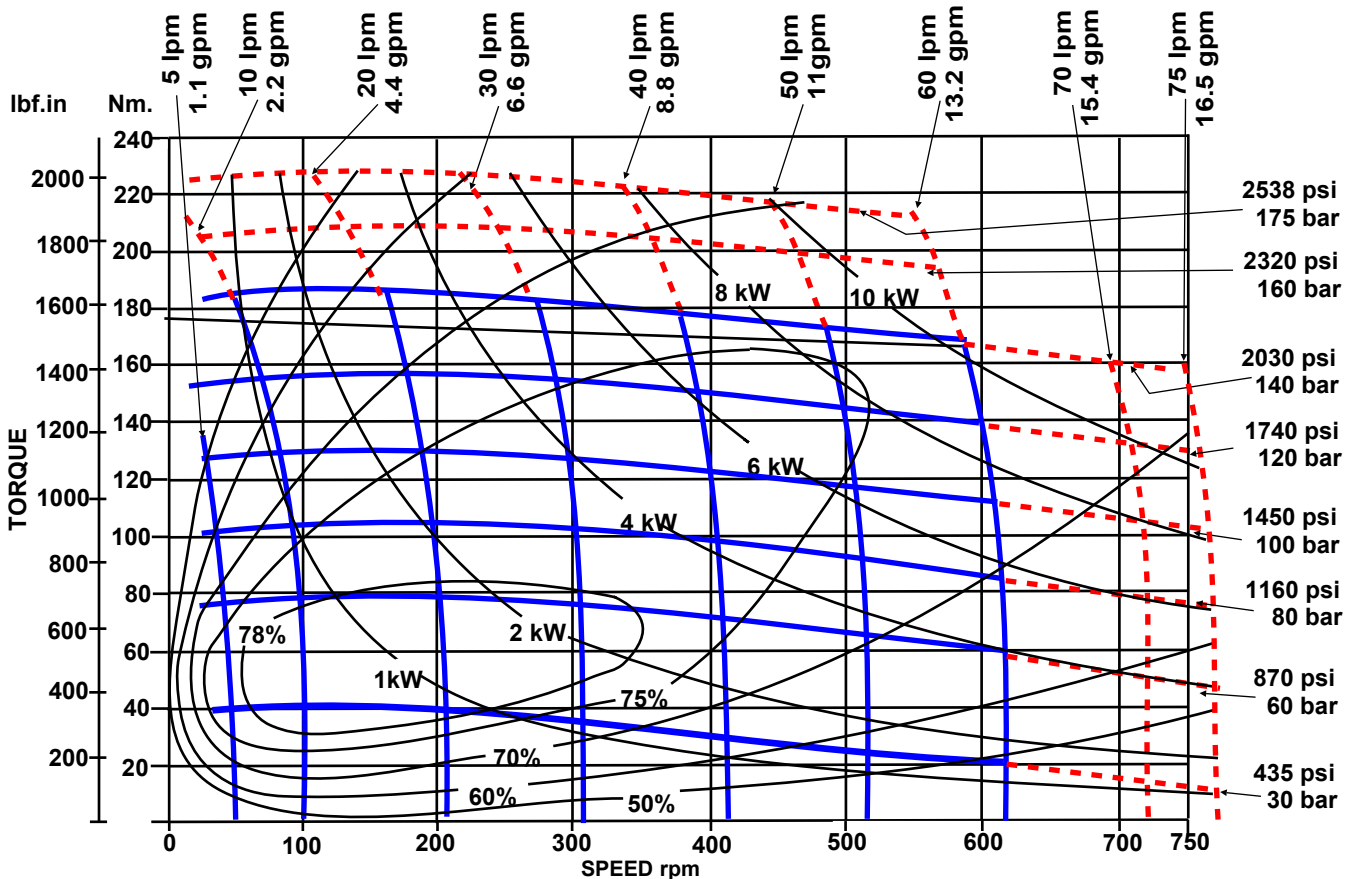

PERFORMANCE GRAPHS 150 & 200 cc COMPACT SERIES

Solid blue lines represent continuous operation. Dotted red lines represent intermittent operation permissible for 10% of every minute.

Maximum pressure drop and maximum speed must not occur simultaneously.

Maximum values are dependant on shaft type see note on page 3.

COMPACT 150

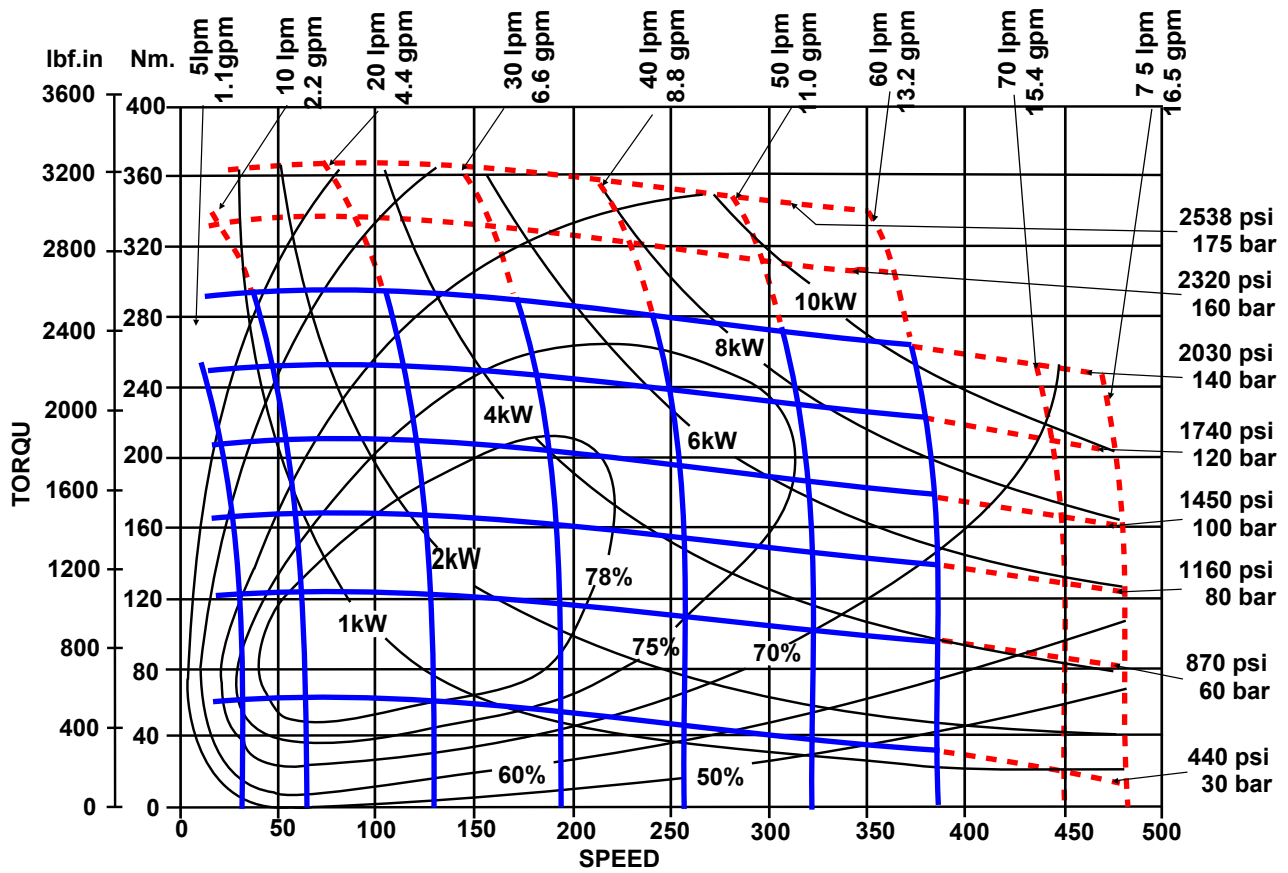

COMPACT 200

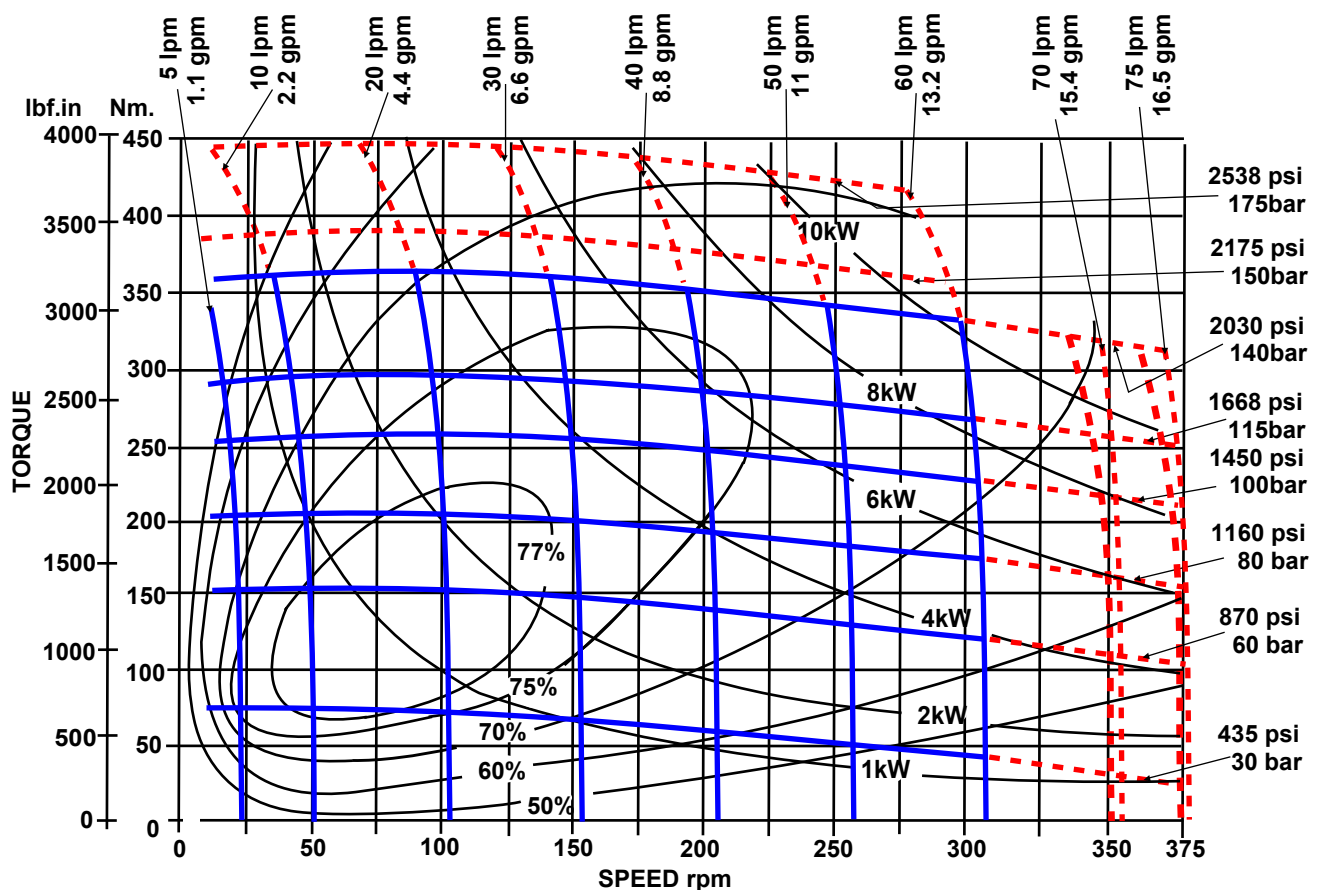

PERFORMANCE GRAPHS 300 & 400 cc COMPACT SERIES

Solid blue lines represent continuous operation. Dotted red lines represent intermittent operation permissible for 10% of every minute.

Maximum pressure drop and maximum speed must not occur simultaneously.

Maximum values are dependant on shaft type see note on page 3.

COMPACT 300

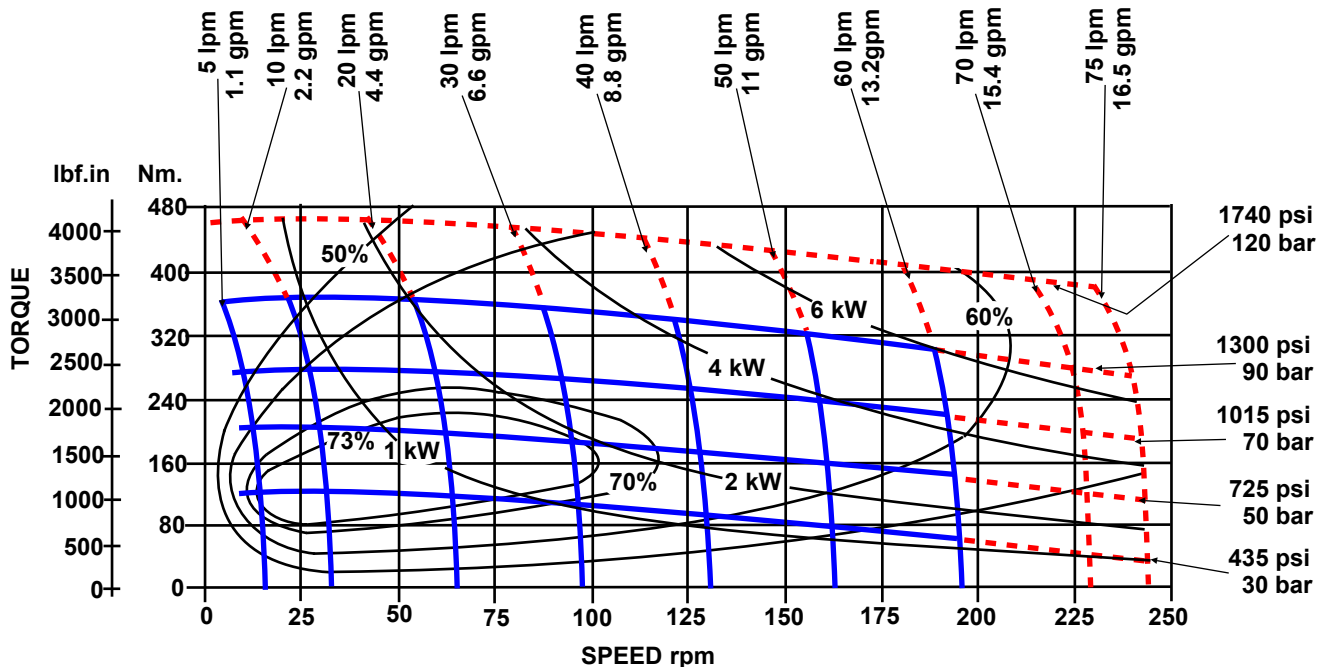

COMPACT 400

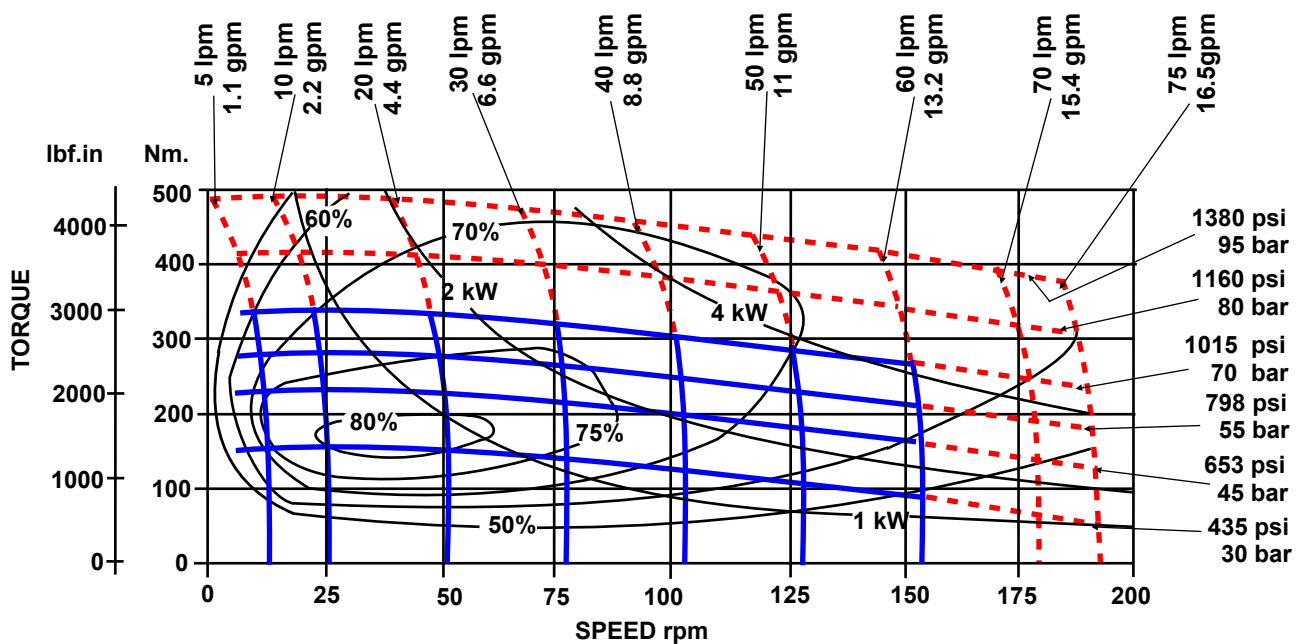

The policy of Adan Limited is one of continual development and the right is reserved to alter specifications without notice.



ADAN LIMITED

RIVERSIDE IND. ESTATE BOSTON LINCOLNSHIRE ENGLAND
 Tel: +44 (01205) 311500 Fax: +44 (01205) 358013
 email: sales@adanltd.co.uk website: www.adanltd.co.uk

