



E SERIES

HYDRAULIC MOTOR

HIGH TORQUE - LOW SPEED



TYPE		AEMP										
MOTOR SIZE		32	50	63	75	100	125	150	200	250	300	400
DISPLACEMENT	cm ³	33.0	49.7	65.9	81.8	101.2	126.1	160.8	200.9	250.8	315.5	399.9
	in ³	2.02	3.04	4.04	5.01	6.20	7.72	9.85	12.30	15.36	19.32	25.27
MAX. SPEED	rpm cont.	1400	775	750	750	600	475	375	300	240	190	160
	rpm int.	1600	1000	1000	940	750	600	450	375	300	240	200
MAX. TORQUE	Nm cont.	44	100	140	195	240	300	360	360	360	360	360
	lbf.in cont.	390	885	1240	1730	2120	2660	3190	3190	3190	3190	3190
	Nm int.	62	130	170	220	280	340	430	440	470	470	460
	lbf.in int.	550	1150	1505	1950	2480	3010	3810	3890	4160	4160	4070
MAX. PRESSURE DROP	bar cont.	100	140	140	175	175	175	165	130	100	85	70
	psi int.	1450	2030	2030	2540	2540	2540	2390	1890	1450	1230	1020
	bar int.	140	175	175	200	200	200	200	175	140	115	90
MAX. OIL FLOW	psi int.	2030	2540	2540	2900	2900	2900	2900	2540	2030	2030	1310
	lpm cont.	50	40	50	60	60	60	60	60	60	60	60
	gpm cont.	11	8.8	11	13.2	13.2	13.2	13.2	13.2	13.2	13.2	13.2
	lpm int.	55	50	62	75	75	75	75	75	75	75	75
WEIGHT kg	gpm int.	12.2	11	13.6	16.5	16.5	16.5	16.5	16.5	16.5	16.5	16.5
	AEMP & - 4	6.2	6.4	6.7	6.8	7.1	7.3	7.5	8.0	8.5	8.9	9.9
	AEMP-RP	7.3	7.5	7.8	7.9	8.2	8.4	8.6	9.1	9.6	10.0	11.0

Maximum inlet pressure 3250 psi - 224 bar
 High pressure shaft seal drain line not required for most applications.

Maximum pressure drop and speed must not be reached simultaneously.
 Intermittent operation may occur for 10% max. of every minute.

At speeds lower than 10 rpm please consult our Technical Department.

Mineral based hydraulic fluids with anti-wear additives are recommended with a viscosity of 35 mm²/s at a temperature of 50 C.

Minimum recommended oil viscosity 13 mm²/s at operating temperature.

Recommended oil cleanliness ISO 19/14 with a nominal filtration of 25 micron or better.

Where non-flammable fluids are to be used it is advisable to consult our Technical Department.

Ambient temperature should be between -30°C and +90°C.

Normal operating temperature should be between +30°C and +60°C.

Maximum operating temperature +85°C.

SYMBOL

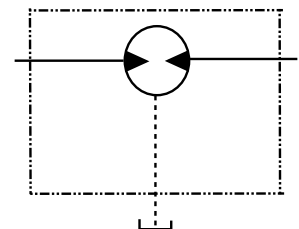

The policy of Adan Limited is one of continual development and the right is reserved to alter specifications without notice.



ADAN LIMITED

RIVERSIDE IND. ESTATE BOSTON LINCOLNSHIRE ENGLAND
 Tel: +44 (01205) 311500 Fax: +44 (01205) 358013
 email: sales@adanltd.co.uk website: www.adanltd.co.uk



Metric Shaft - M

Imperial Shaft - E

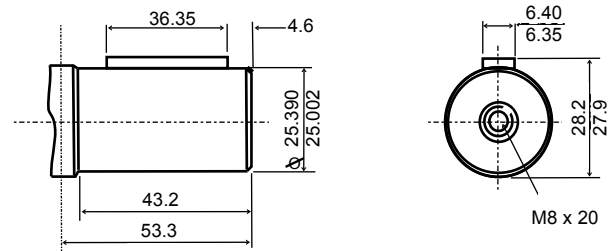
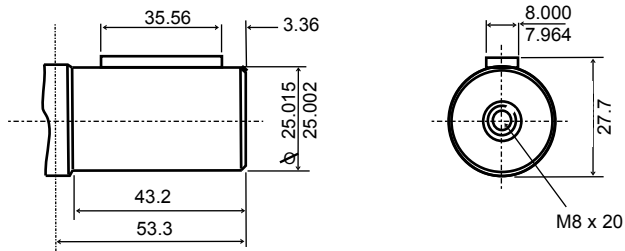

Splined Shaft - S

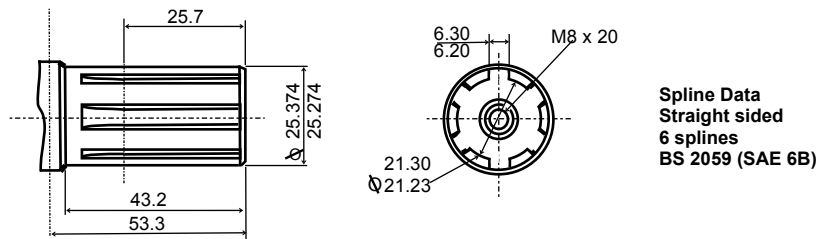

Note Torque limitations

Shafts M & E cont. 300 Nm (2660lbf.in) int. 420 Nm (3720lbf.in)

Shaft S cont. 360Nm (3190 lbf.in) int. 470 Nm (4160lbf.in)

The policy of Adan Limited is one of continual development and the right is reserved to alter specifications without notice.



ADAN LIMITED

RIVERSIDE IND. ESTATE BOSTON LINCOLNSHIRE ENGLAND

Tel: +44 (01205) 311500

email: sales@adanltd.co.uk

Fax: +44 (01205) 358013

website: www.adanltd.co.uk



SHAFT ROTATION

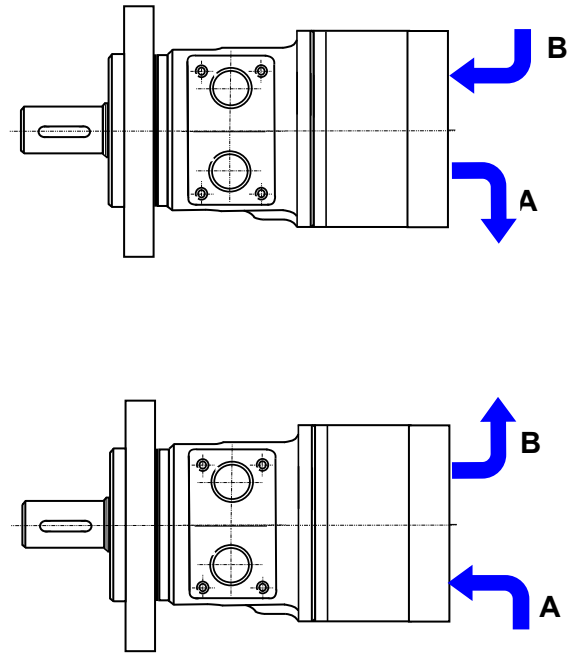
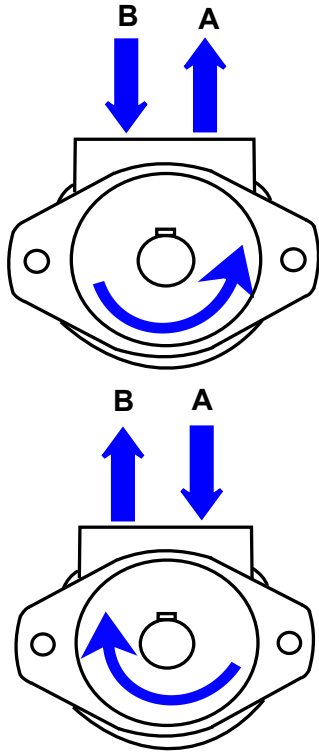

SHAFT LOADING

2 Bolt Flange

$$P = \frac{800}{n} \times \frac{250000}{95 + L} N$$

$$P = \frac{800}{n} \times \frac{2215}{3.74 + L} lbf$$

4 Bolt Flange

$$P = \frac{800}{n} \times \frac{250000}{101 + L} N$$

$$P = \frac{800}{n} \times \frac{2215}{3.98 + L} lbf$$

n = speed rpm
 For metric L in mm
 For imperial L in inches

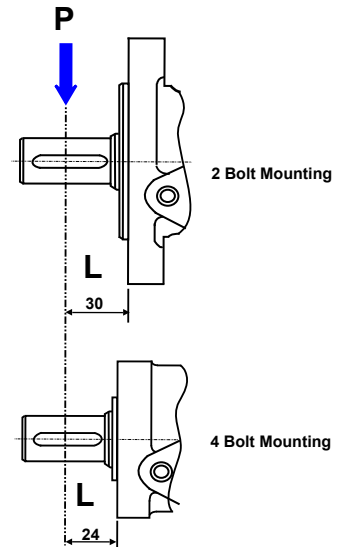
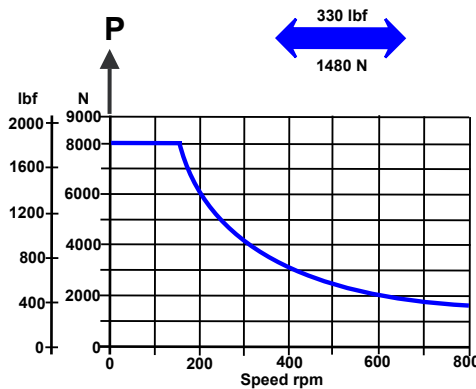

ORDERING CODE

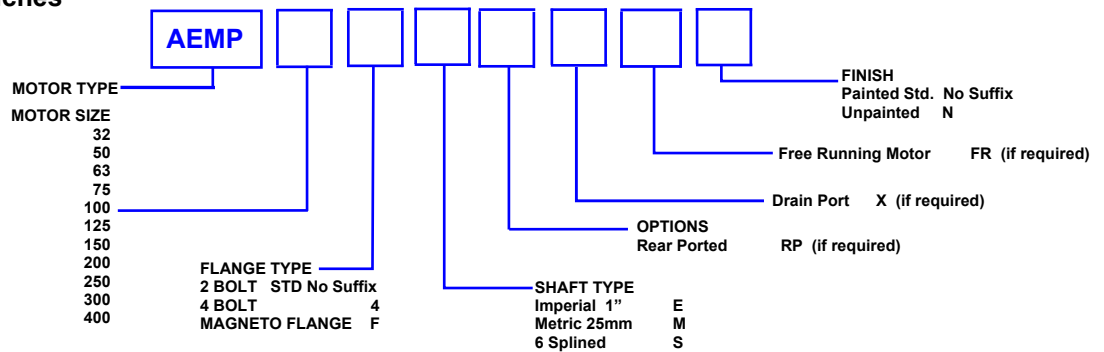

The policy of Adan Limited is one of continual development and the right is reserved to alter specifications without notice.



ADAN LIMITED

RIVERSIDE IND. ESTATE BOSTON LINCOLNSHIRE ENGLAND
 Tel: +44 (01205) 311500 Fax: +44 (01205) 358013
 email: sales@adanltd.co.uk website: www.adanltd.co.uk



Solid lines represent continuous operation. Dotted lines represent intermittent operation. Intermittent operation = 10% of every minute. Maximum pressure drop and maximum speed must not occur simultaneously.

Maximum values are dependant on shaft type see note on page 3

AEMP 32

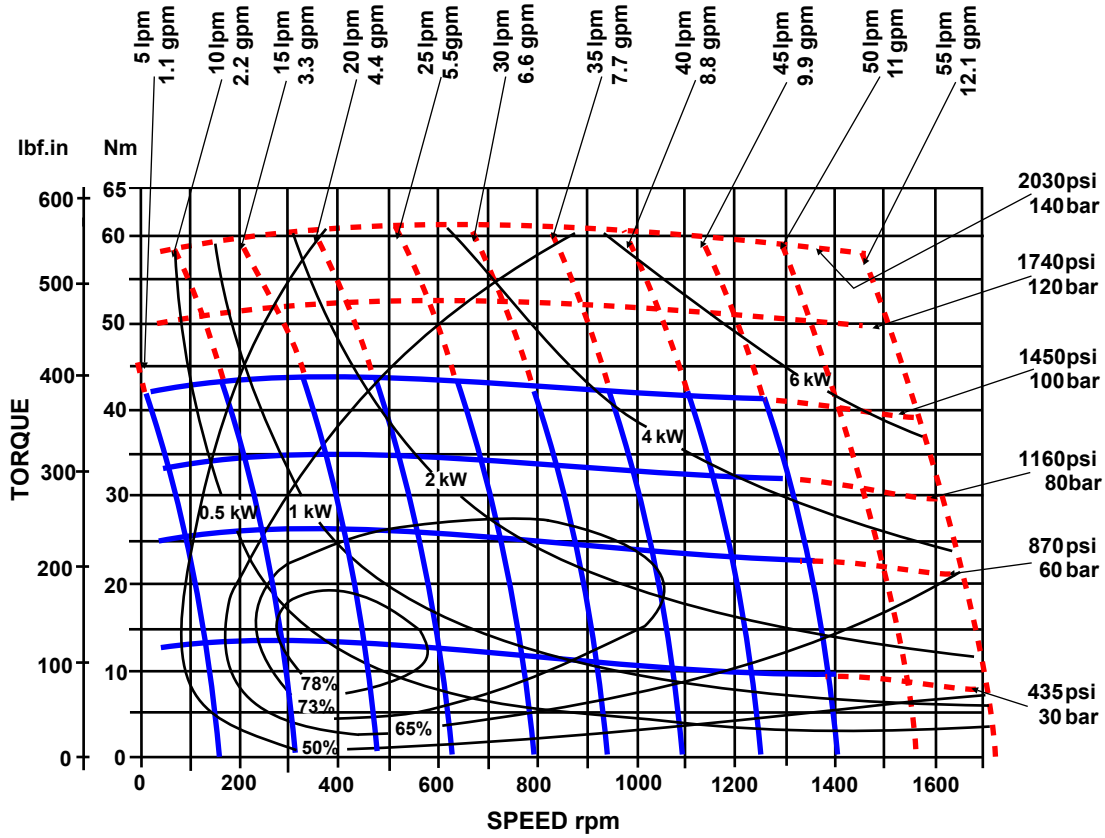

AEMP 50

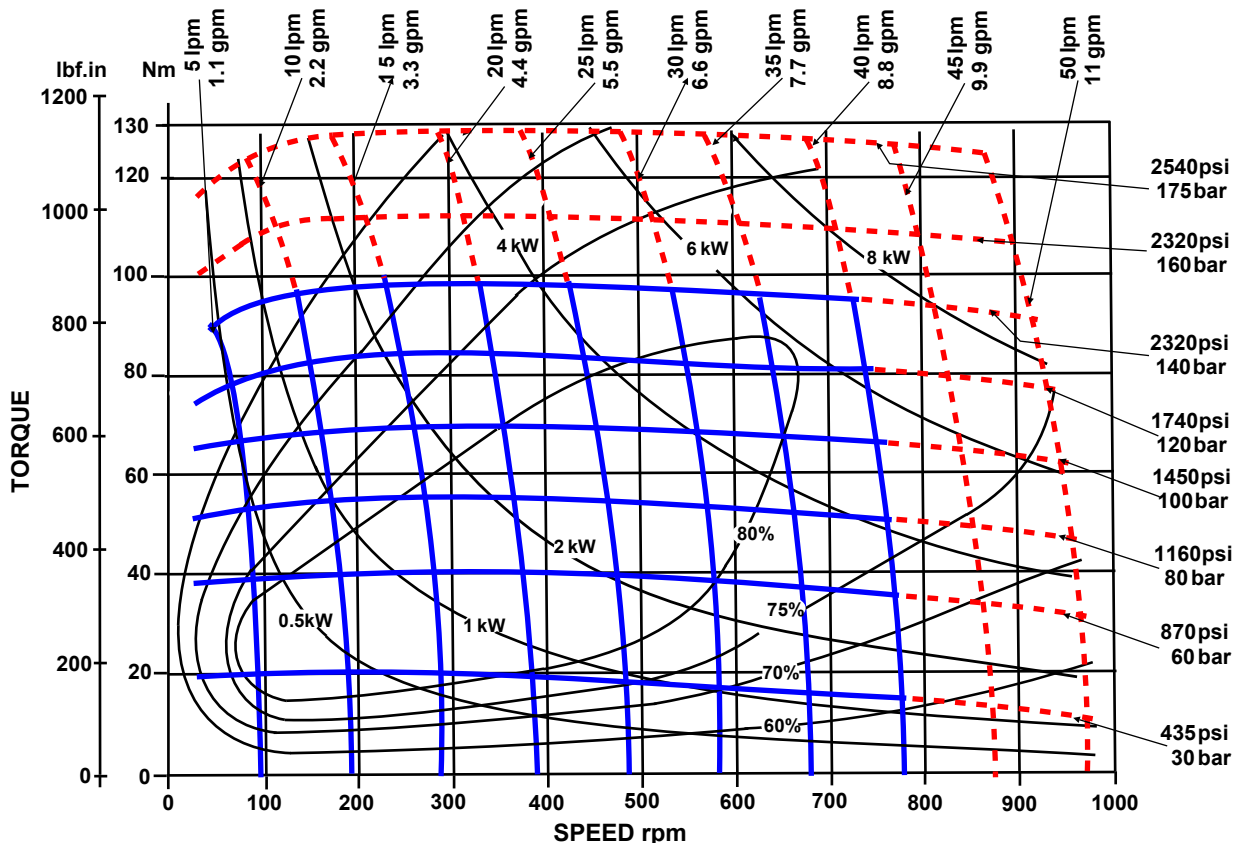

Solid lines represent continuous operation. Dotted lines represent intermittent operation. Intermittent operation = 10% of every minute. Maximum pressure drop and maximum speed must not occur simultaneously.

Maximum values are dependant on shaft type see note on page 3

AEMP 63

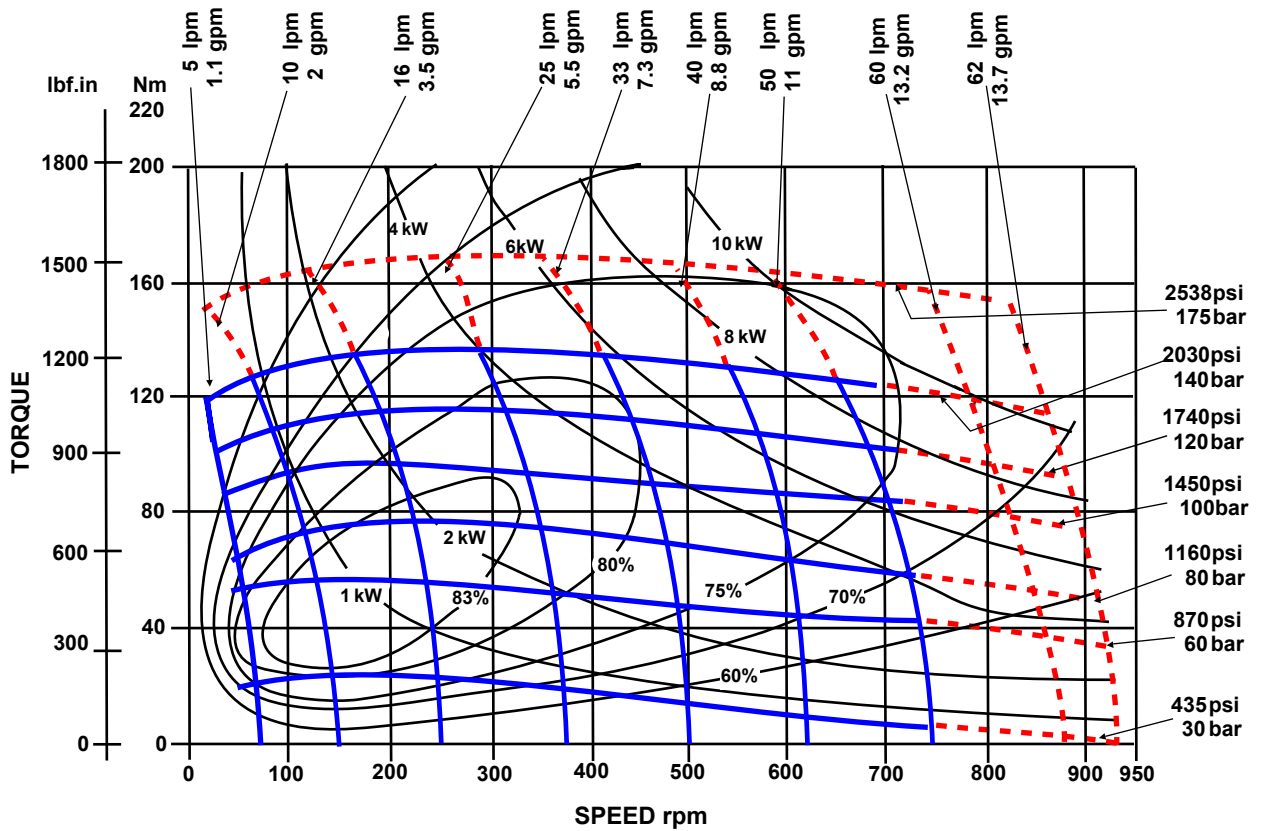

AEMP 75

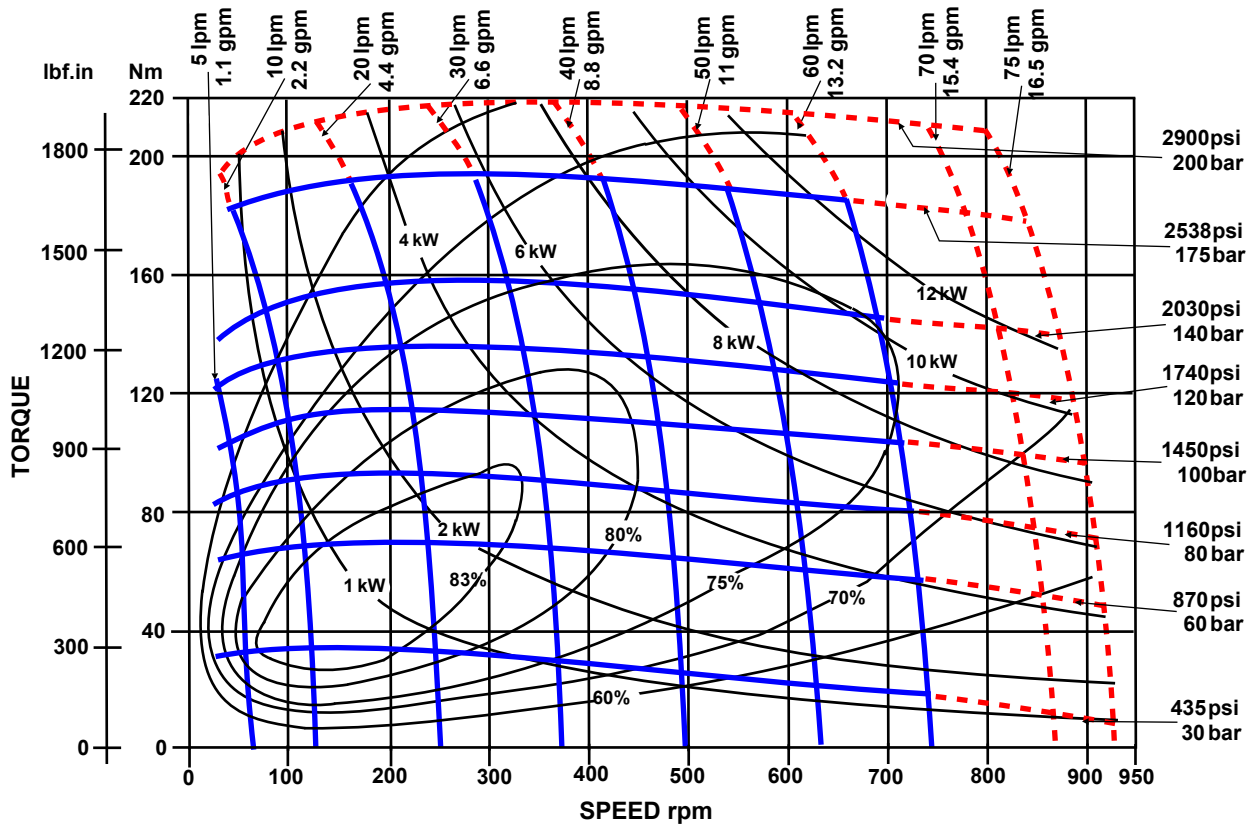

Solid lines represent continuous operation. Dotted lines represent intermittent operation. Intermittent operation = 10% of every minute. Maximum pressure drop and maximum speed must not occur simultaneously.

Maximum values are dependant on shaft type see note on page 3

AEMP 100

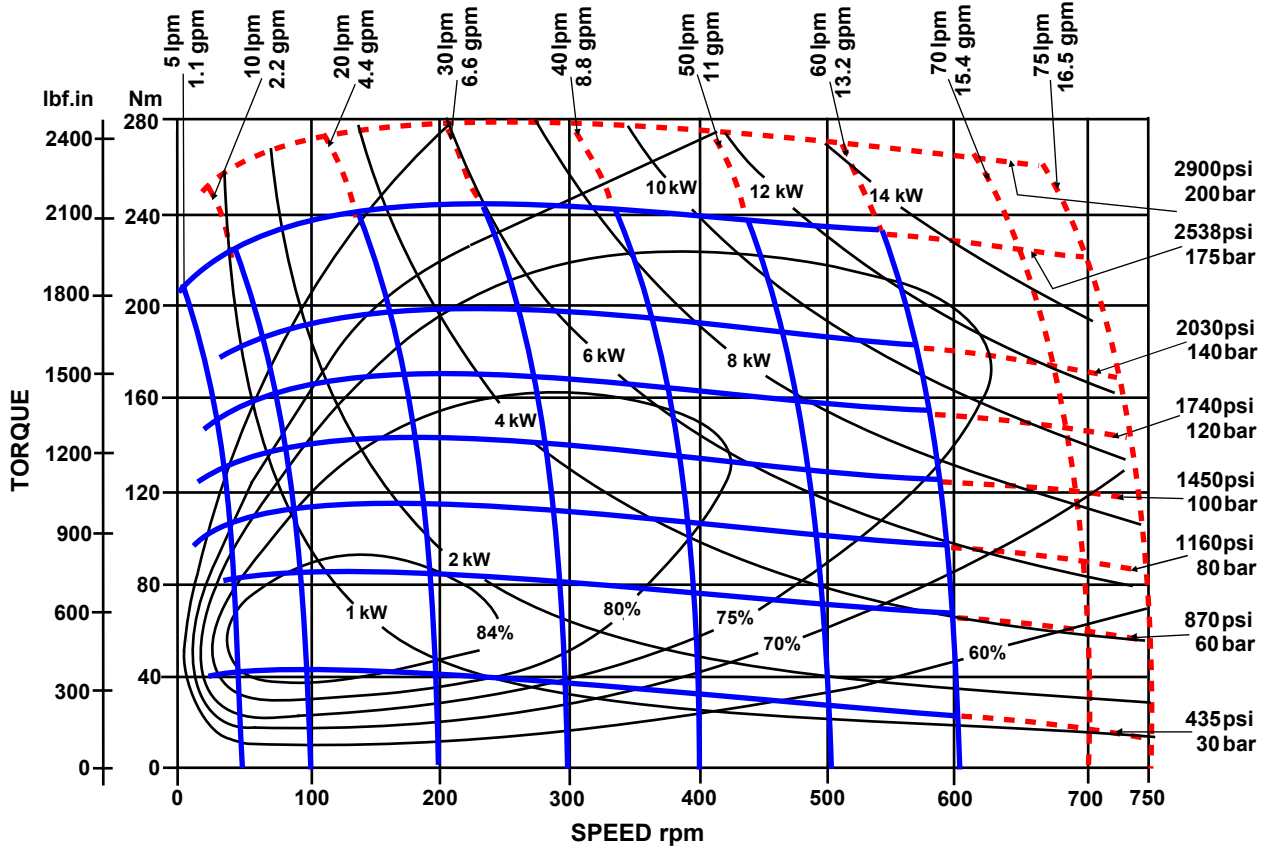

AEMP 125

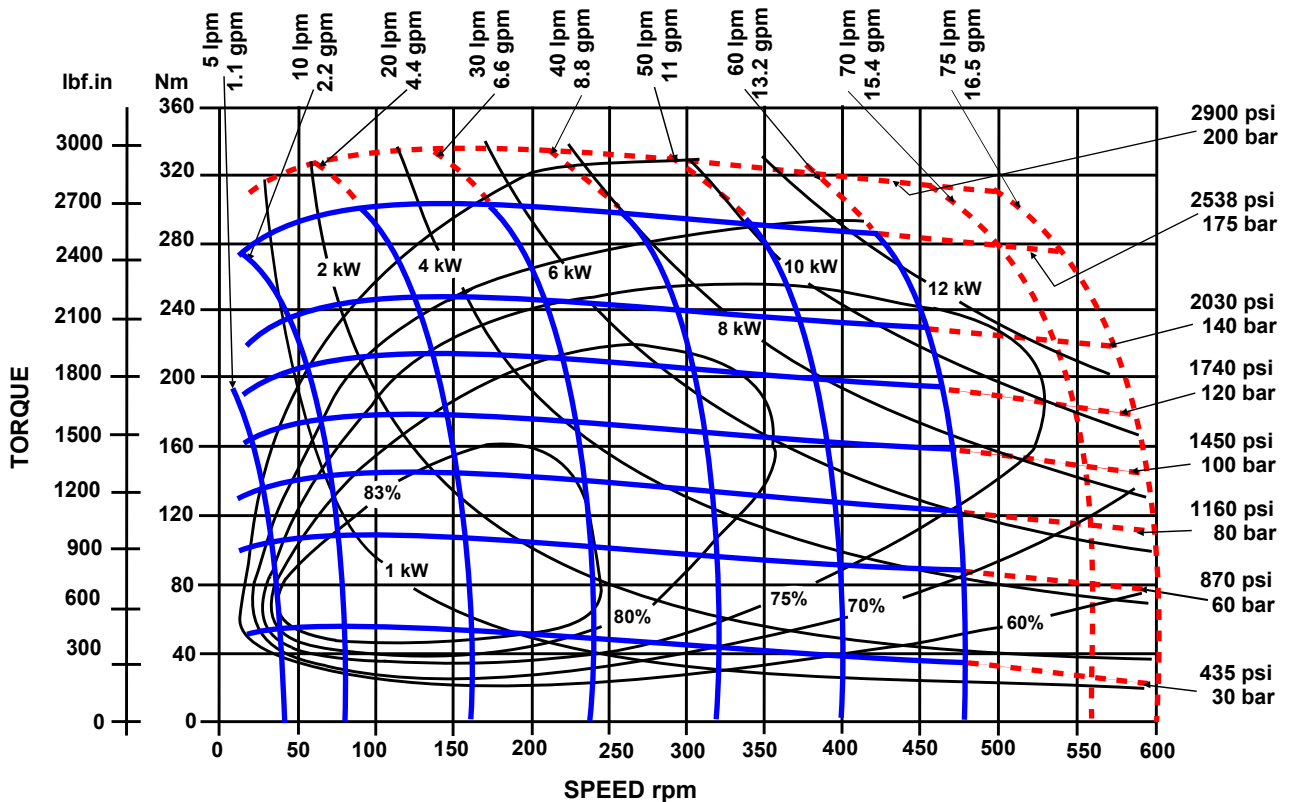

Solid lines represent continuous operation. Doted lines represent intermittent operation. Intermittent operation = 10% of every minute. Maximum pressure drop and maximum speed must not occur simultaneously.

Maximum values are dependant on shaft type see note on page 3

AEMP 150

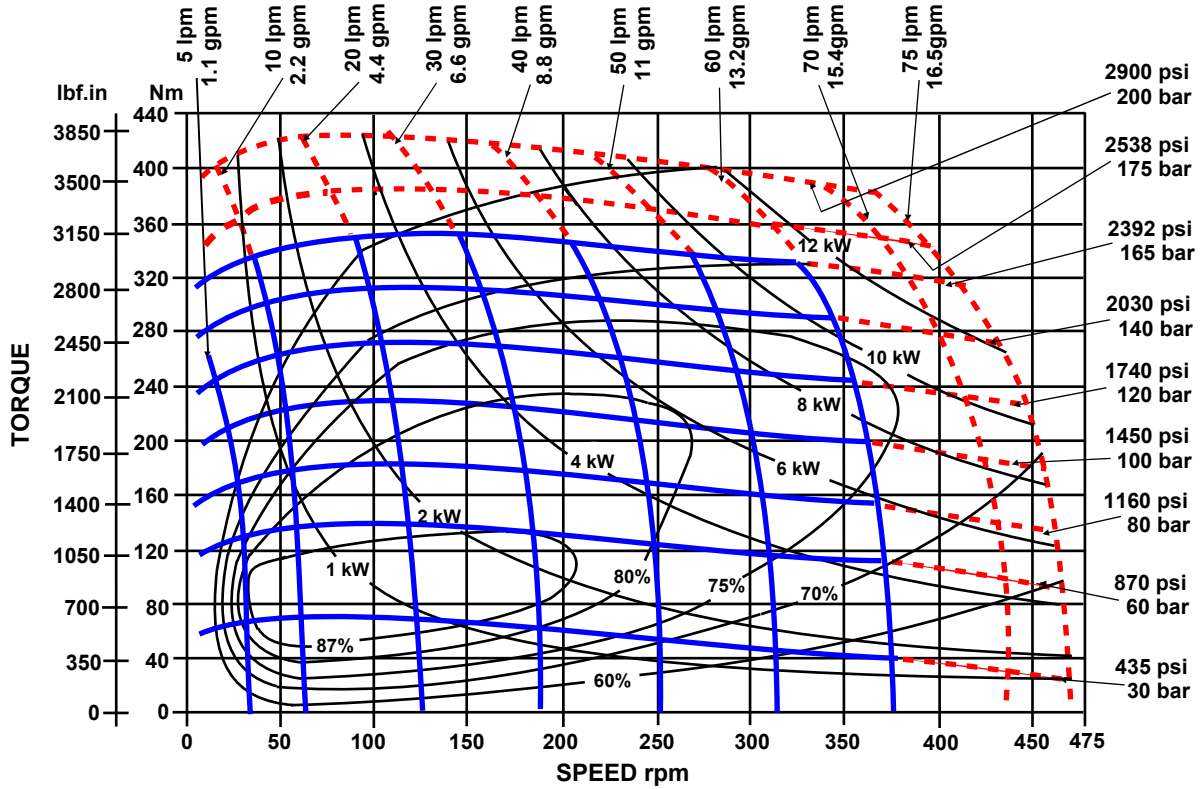

AEMP 200

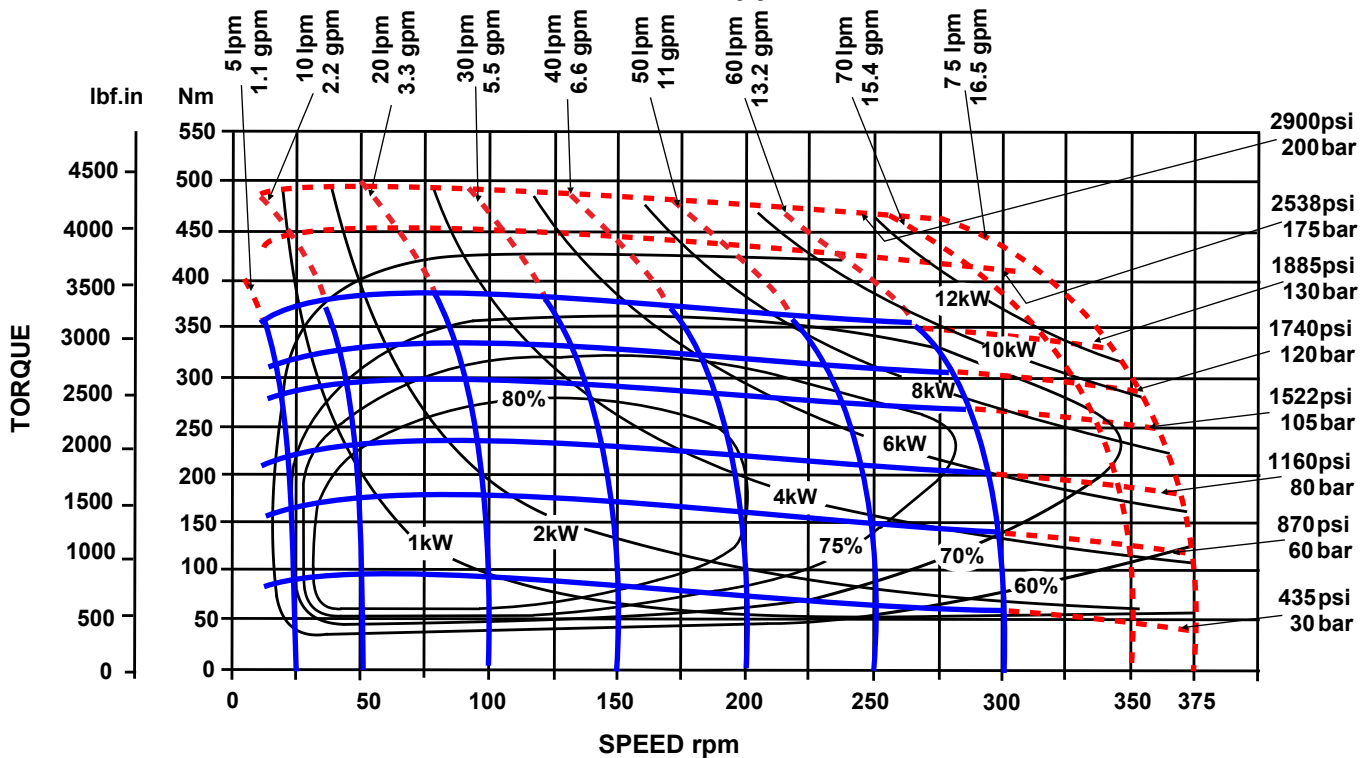

Solid lines represent continuous operation. Dotted lines represent intermittent operation. Intermittent operation = 10% of every minute. Maximum pressure drop and maximum speed must not occur simultaneously.

Maximum values are dependant on shaft type see note on page 3

AEMP 250

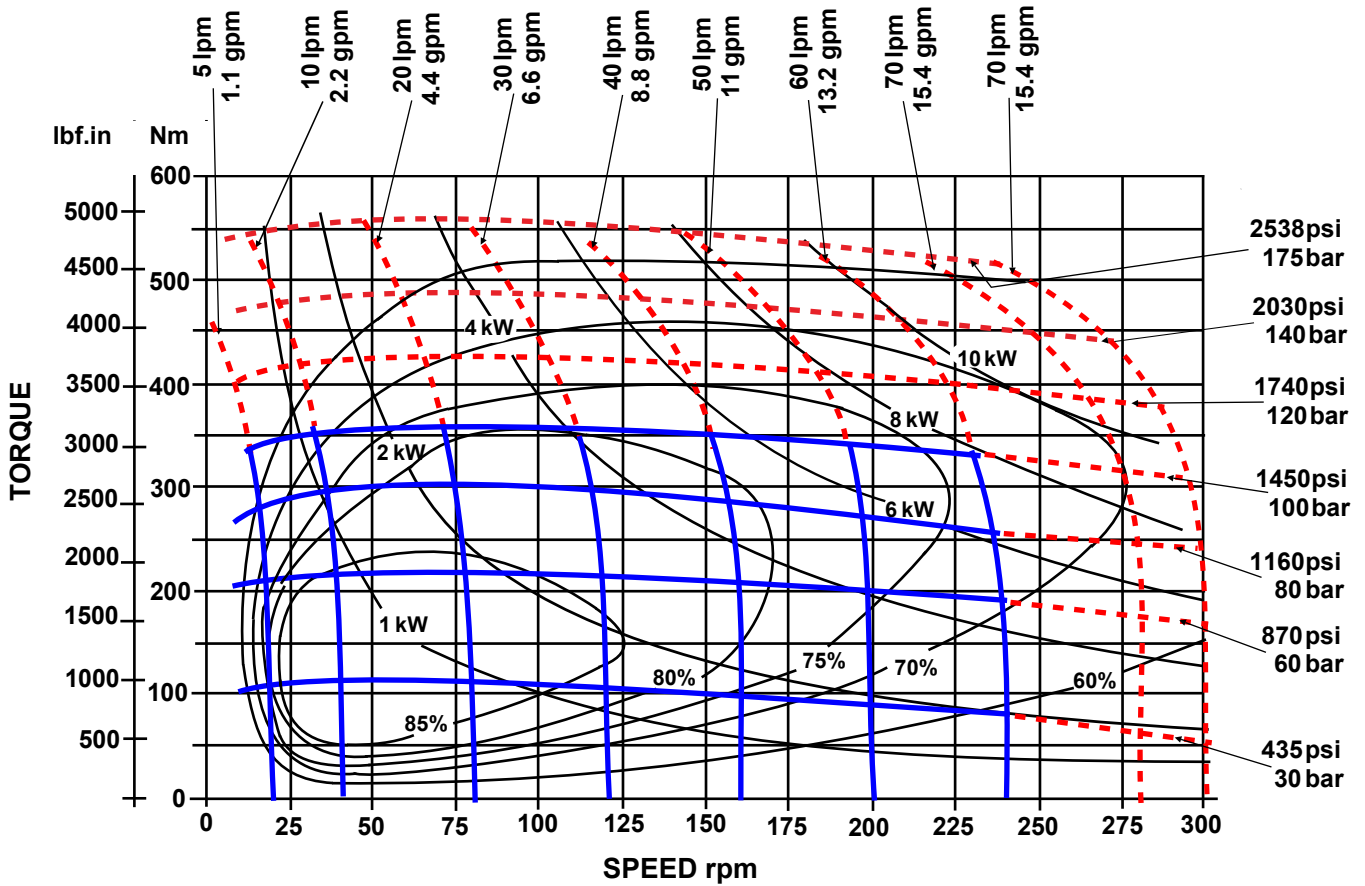

AEMP 300

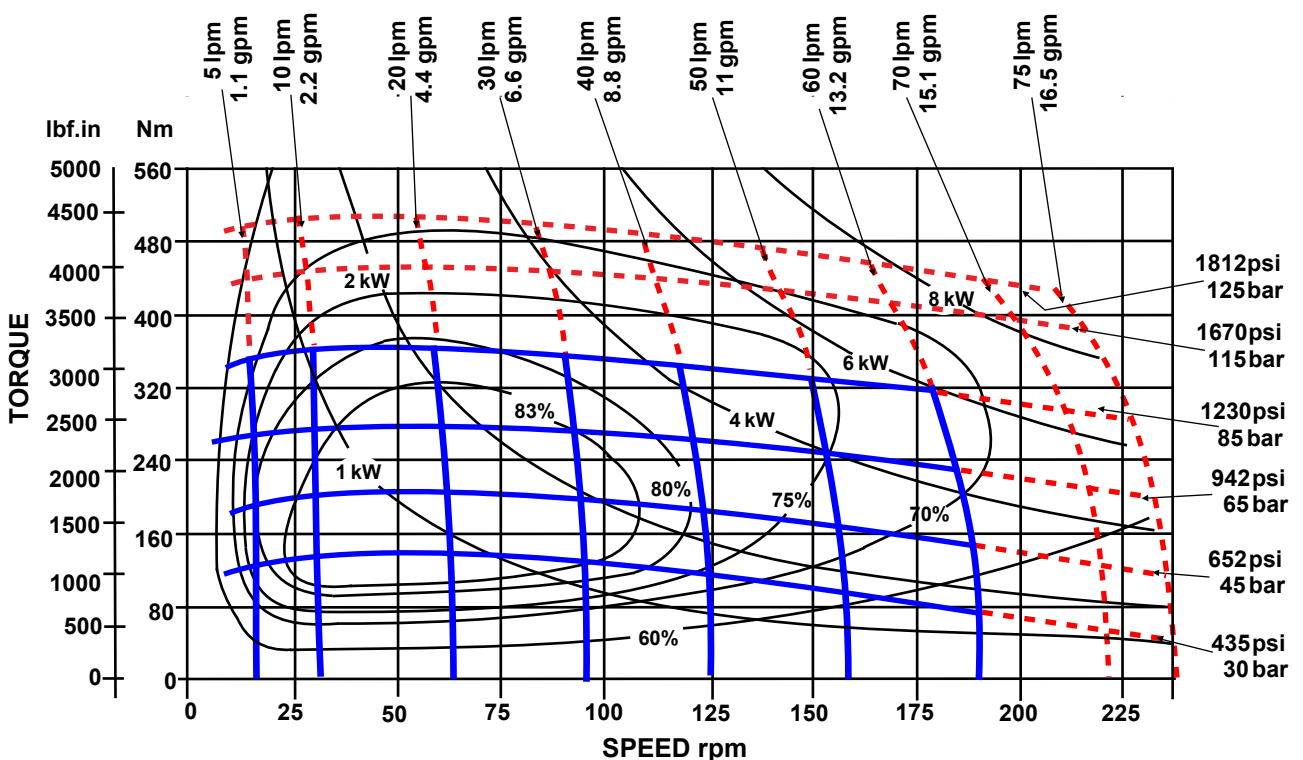

Solid lines represent continuous operation. Dotted lines represent intermittent operation. Intermittent operation = 10% of every minute. Maximum pressure drop and maximum speed must not occur simultaneously.

Maximum values are dependant on shaft type see note on page 3

AEMP 400

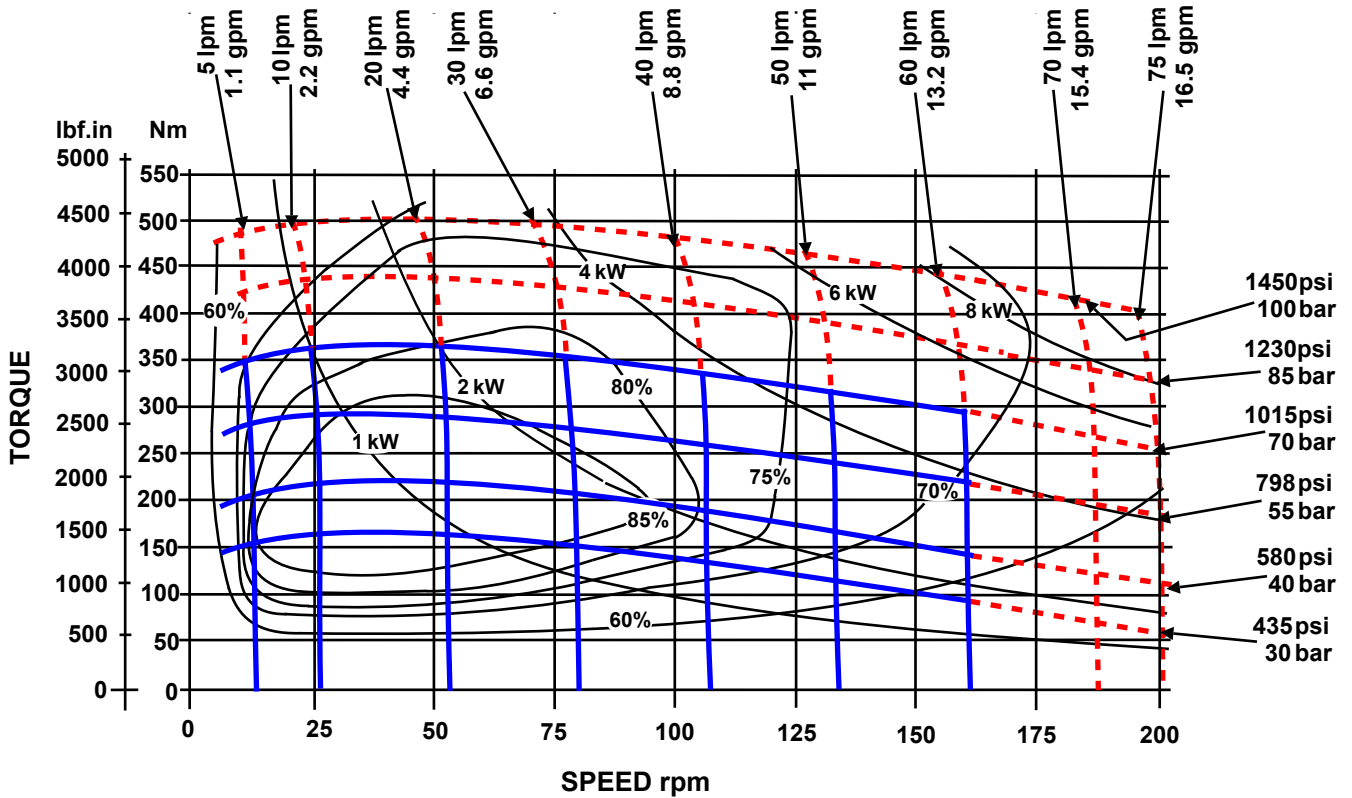

The policy of Adan Limited is one of continual development and the right is reserved to alter specifications without notice.



ADAN LIMITED

RIVERSIDE IND. ESTATE BOSTON LINCOLNSHIRE ENGLAND
 Tel: +44 (01205) 311500 Fax: +44 (01205) 358013
 email: sales@adanltd.co.uk website: www.adanltd.co.uk

